

# WIN

Go to [www.LEGO.COM/RB2022](http://www.LEGO.COM/RB2022) to fill out a short survey on this product for a chance to win a cool LEGO® set.

Terms & Conditions apply

## LEGO.com / RB2022

**GAGNE**

Rendez-vous au [www.LEGO.com/RB2022](http://www.LEGO.com/RB2022) pour remplir un court questionnaire sur ce produit et courir la chance de gagner un fantastique ensemble LEGO®.  
Voir Conditions Générales

**GANA**

Visita [www.LEGO.com/RB2022](http://www.LEGO.com/RB2022) y responde una breve encuesta sobre este producto. ¡Puedes ganar un fantástico set LEGO®!  
Términos y Condiciones aplicables



30630

3 IN 1

# GAMES



R.K.

6432310

4

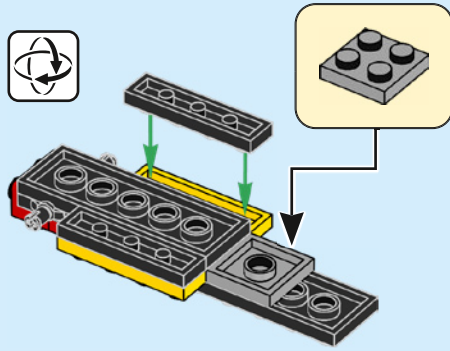

3

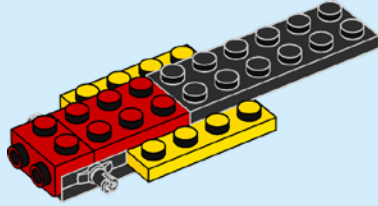

2

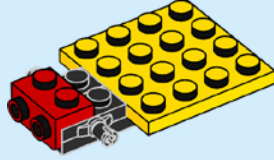

1

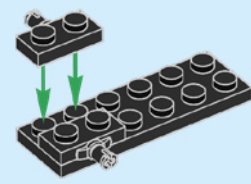

8

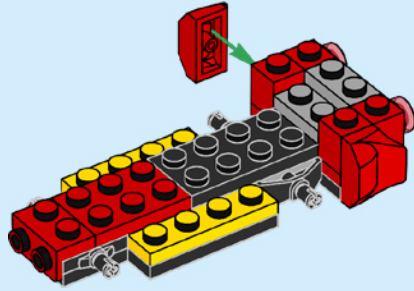

7

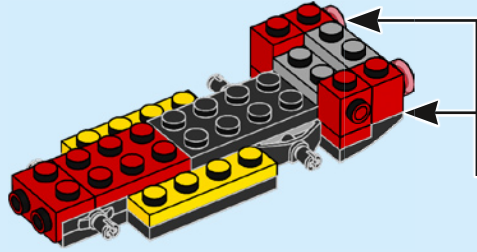

2



1

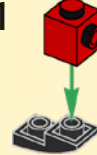

6

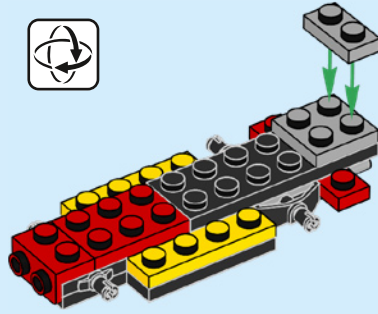

5

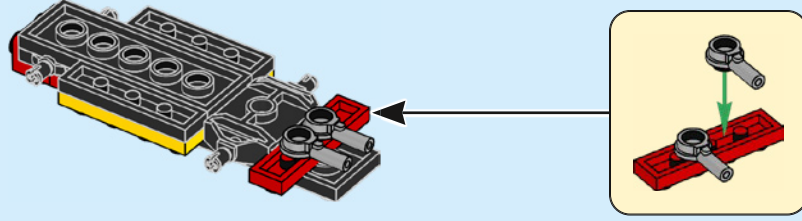

9

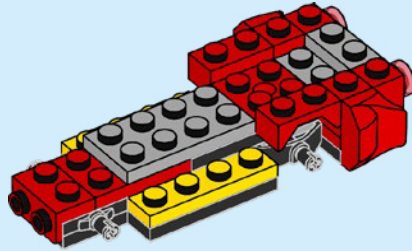

13

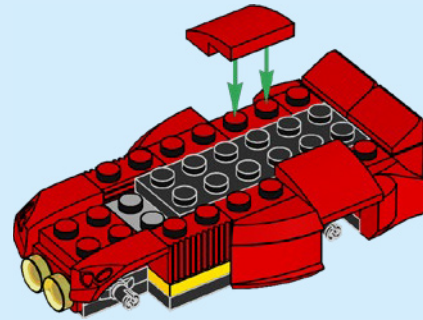

10

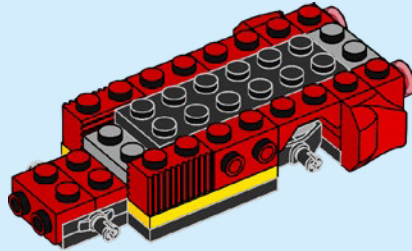

14

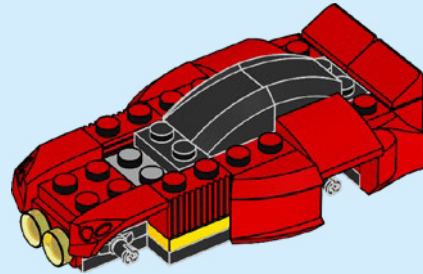

11

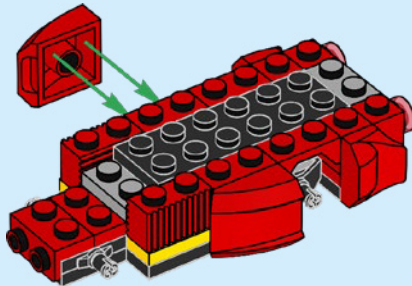

15

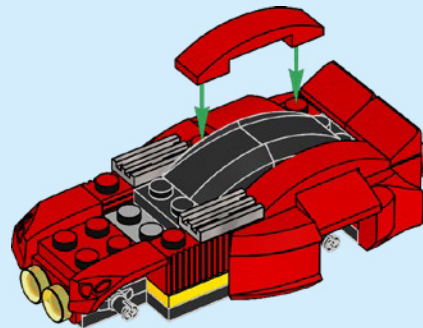

12

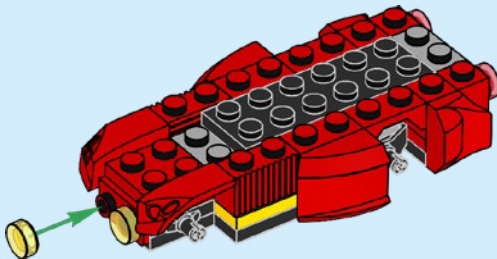

16

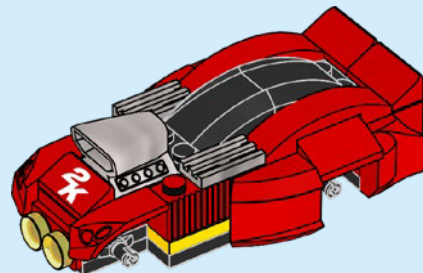

17

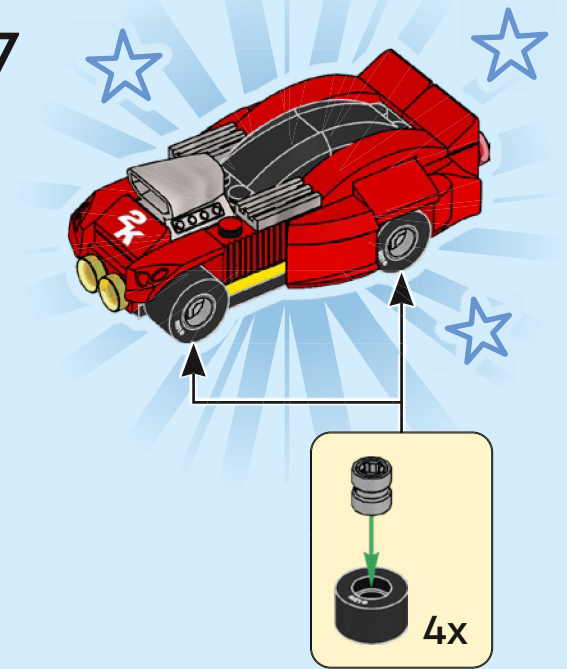

[LEGO.com/service](https://www.lego.com/service)

LEGO and the LEGO logo are trademarks of the/sont des marques de commerce du/son marcas registradas de LEGO Group. ©2022 The LEGO Group. 6432310

©2022 Take-Two Interactive Software, Inc. 2K and the 2K logo are trademarks of Take-Two Interactive Software, Inc. All Rights Reserved.

